



KEYSTONE F89 PNEUMATIC QUARTER-TURN ACTUATOR
 GENERAL PURPOSE / HAZARDOUS AREA



FEATURES

- Direct mounting to all Keystone butterfly valves and ball valves.
- Valve connection compatible with Keystone (imperial and metric) and ISO 5211.
- Double Rack and Pinion design nullifies side loads on the pinion shaft, minimizing bearing wear and extending life.
- Optimized product flow with standard mounted travel stops for valve position adjustment in open and close position (+/- 5° at each end).
- Anodized aluminium body with electrostatic powder coating (ESPC) finish provides durable protection against corrosive environments.
- Double acting and spring return versions available for cost effective and safe operation.
- Up to 12 individual springs offer flexible torque range for both ball as butterfly valves.
- Pre-compressed spring design and anti-blowout drive pinion means safe maintenance and operation.

MATERIALS

Body: Extruded aluminium (ESPC coated)
 End caps: Cast aluminium (ESPC coated)

MOUNTING SPECIFICATIONS

Actuator to valve: ISO and Keystone standard
 Accessories: Namur VDI/VDE 3845

TECHNICAL DATA

Torque output range:
 Double acting: 11 - 4173 Nm (97 - 36955 in-lb)
 Spring return: 6 - 1663 Nm (51 - 14729 in-lb)
 Operating medium: Compressed air (dry or lubricated)
 Air supply pressure: 8.3 bar (120 psi) max. dynamic
 10 bar (140 psi) max. static
 Travel adjustment: +/- 5° at each end of travel
 0-100% travel stop available on request
 Temperature range: -20°C to +80°C (-4°F to +176°F)
 Low temp version: -50°C to +65°C (-58°F to +149°F)
 High temp version: -15°C to +150°C (5°F to +302°F)
 Certification: ATEX II 2 GD IIC T6

KEYSTONE F89 PNEUMATIC QUARTER-TURN ACTUATOR

GENERAL PURPOSE / HAZARDOUS AREA

PRINCIPLE OF OPERATION

Both the double acting and spring return actuators feature a compact design each with their own set of end caps. The unit can be converted from double acting to single acting (or reverse) in the field without the requirement of special tools. The spring return actuator is available with spring sets representing 2.8 bar (40 psi) to 8.3 bar (120 psi) in 0.7 bar (10 psi) increments. The springs are manufactured from heavy gauge wire to assure long life and ESPC coated for corrosion resistance. They are pre-compressed using a special container to ensure safe operation and maintenance.

The dual-keyed output shaft allows parallel or perpendicular mounting to the valve flow direction. In normal conditions the actuator is mounted in parallel with the valve flow direction, operating in a counter clockwise (CCW) rotation from the closed to the open position.

DOUBLE ACTING

To open valve

In a double acting application, air pressure is introduced to Port 2 (A), pressurizing the space between the pistons and driving the pistons out towards the actuator ends. The volume of air above the piston heads is exhausted to atmosphere. This causes the piston racks to drive the pinion in a counterclockwise direction, resulting in a quarterturn rotation. This rotation is transferred to the valve shaft, opening the valve.

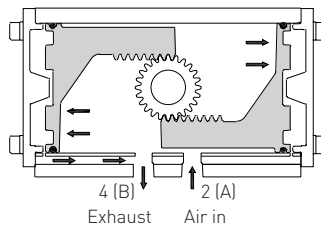

The standard operation direction of the spring fail close action is clockwise (CW). By rotating the pistons 180 degrees in the body in relation to the pinion, the actuator operation direction can be reversed. Although rotating the actuator 90 degrees will have a similar effect, the piston rotation is preferred as it maintains the parallel mounting and keeps the valve operation in the correct quadrant.

To close valve

Air pressure introduced to Port 4 (B), pressurizes the spaces above each piston head and drives the pistons inward. The volume of air between the pistons is exhausted to atmosphere. This causes the piston racks to drive the pinion in a clockwise direction, resulting in a quarter-turn rotation. This rotation is transferred to the valve shaft, closing the valve.

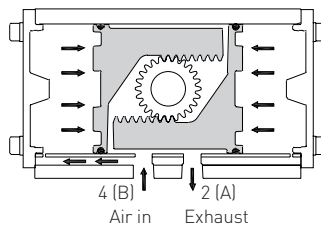

SPRING RETURN

To open valve

In a single acting application, air pressure is introduced to Port 2 (A), pressurizing the space between the pistons and driving the pistons out towards the actuator ends while at the same time compressing the springs. This causes the piston racks to drive the pinion in a counterclockwise direction, resulting in a quarter-turn rotation. This rotation is transferred to the valve shaft, opening the valve.

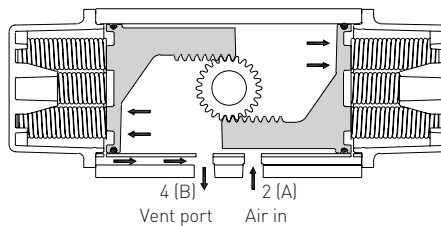

To close valve

When the air pressure is relieved, the spring tension moves the pistons inward and exhausts the air through Port 2 (A). This causes the piston racks to drive the pinion in a clockwise direction, resulting in a quarter-turn rotation. This rotation is transferred to the valve shaft, closing the valve.

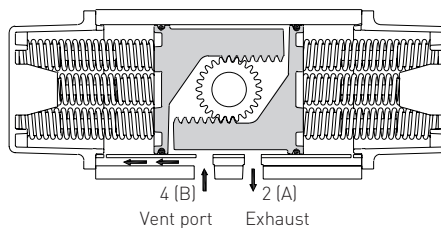

KEYSTONE F89 PNEUMATIC QUARTER-TURN ACTUATOR

GENERAL PURPOSE / HAZARDOUS AREA

TRAVEL ADJUSTMENT

Within the mechanical connections of the drive between the valve and the actuator there are several points of manufacturing tolerance, including valve disc or ball to stem, stem to adapter, and adapter to actuator that must be compensated for in the operation of the assembly. Therefore, adjustment is necessary to ensure that valve operation is as precise as required. The F89 dual travel stops allow +/-5° adjustment at both ends of the stroke, resulting in a total stroke range of 80° to 100° rotation. For special applications an optional linear travel stop is available, which reduces the stroke from 0-100%.

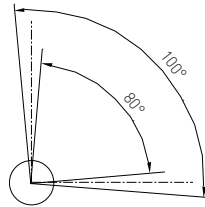

Resilient seated butterfly valves

Shut-off occurs before the disc has rotated a full 90° from the open position. Travel adjustment is therefore desirable to prevent over travel, which would result in unnecessary operating torque and premature deterioration of seat life. In the open position, adjustment is necessary to ensure maximum flow through the valve and minimum dynamic forces acting on the disc.

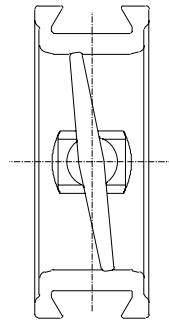

High performance butterfly valves

The double offset design of high performance butterfly valves results in the disc moving into the seat with a camming action. It is important that the disc does not travel beyond the seat position, otherwise damage to the seat will occur.

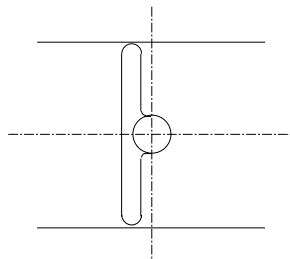

Ball and plug valves

The ball or plug must be precisely in line with the valve port to prevent damage to the seat in the open position. Adjustment at the closed position is necessary to ensure that complete shut-off is achieved.

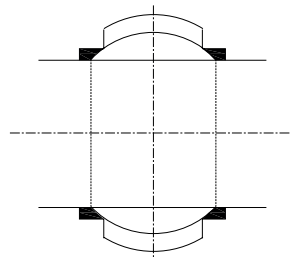

KEYSTONE F89 PNEUMATIC QUARTER-TURN ACTUATOR

GENERAL PURPOSE / HAZARDOUS AREA

DIMENSIONS

Top view

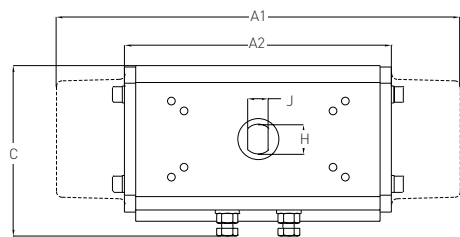

Bottom view

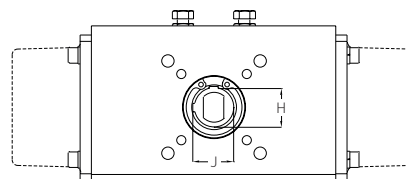

Side view

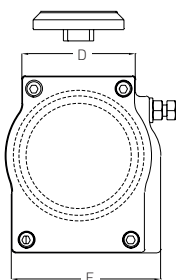

Front view

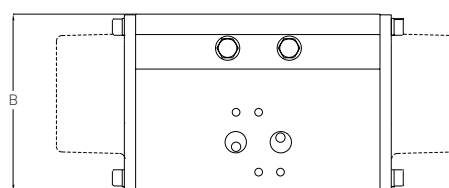

TABLE 1 - DIMENSIONS F89 METRIC (mm)

Model	A1 ⁽¹⁾	A2 ⁽¹⁾	B	C	D	E	Top of shaft ⁽²⁾		
							H	J	Key
F89-002	-	121	72	74	54	66		DD 16.0 x 11.0	
F89-003	186	125	86	81	59	79		DD 16.0 x 11.0	
F89-004	217	143	96	91	61	80		DD 16.0 x 11.0	
F89-006	259	169	101	108	64	87		DD 16.0 x 11.0	
F89-009	257	174	119	124	64	99		DD 16.0 x 11.0	
F89-014	307	193	138	141	78	112		DD 16.0 x 11.0	
F89-020	378	236	155	157	81	123		DD 16.0 x 11.0	
F89-032/033	462	283	171	182	95	136	20.7	21.4	4.8
F89-051/052	476	298	213	210	111	159	20.7	21.4	4.8
F89-084/085/086	627	384	227	233	130	190	25.5	27.0	6.4
F89-139/140/141	726	431	274	288	154	233	25.5	27.0	6.4
F89-240	845	507	325	341	186	290	25.5	27.0	6.4

TABLE 2 - DIMENSIONS F89 IMPERIAL (in)

Model	A1 ⁽¹⁾	A2 ⁽¹⁾	B	C	D	E	Top of shaft ⁽²⁾		
							H	J	Key
F89-002	-	4.76	2.83	2.91	2.13	2.60		DD 5/8 x 7/16	
F89-003	7.30	4.90	3.39	3.18	2.32	3.09		DD 5/8 x 7/16	
F89-004	8.53	5.63	3.78	3.60	2.40	3.15		DD 5/8 x 7/16	
F89-006	10.20	6.65	3.97	4.26	2.52	3.42		DD 5/8 x 7/16	
F89-009	10.10	6.85	4.69	4.87	2.52	3.91		DD 5/8 x 7/16	
F89-014	12.07	7.60	5.42	5.55	3.07	4.41		DD 5/8 x 7/16	
F89-020	14.89	9.29	6.10	6.20	3.19	4.82		DD 5/8 x 7/16	
F89-032/033	18.20	11.14	6.73	7.18	3.74	5.35	0.81	0.84	0.19
F89-051/052	18.72	11.73	8.37	8.25	4.37	6.26	0.81	0.84	0.19
F89-084/085/086	24.69	15.12	8.94	9.17	5.12	7.48	1.00	1.06	0.25
F89-139/140/141	28.58	16.97	10.79	11.34	6.06	9.17	1.00	1.06	0.25
F89-240	33.27	19.96	12.80	13.43	7.32	11.42	1.00	1.06	0.25

NOTES

1. A1 = spring return; A2 = double acting
2. All actuators have either DD 16.0 x 11.0 [DD 5/8 x 7/16] top shaft connection or plastic insert to this dimension, for direct mounting of AVID accessories.

KEYSTONE F89 PNEUMATIC QUARTER-TURN ACTUATOR

GENERAL PURPOSE / HAZARDOUS AREA

The F89 actuator is available with 4 different valve connections: F89D - ISO 5211 (metric threaded); F89E - Keystone ISO (metric threaded); F89U - Keystone imperial + metric threaded

TABLE 3A - VALVE CONNECTION ISO FLANGE (mm)

Model	F89E - Keystone ISO				F89D - ISO 5211			
	Bottom of shaft		Key	PCD	Mounting holes		Bottom of shaft	
H	J	No x Size x Depth			Drive: Star no	PCD	No x Size x Depth	
F89-002	16.0	11.0		F03 F05	4x M5 x 8.0 4x M6 x 10.0	14	F03 F05	4x M5 x 8.0 4x M6 x 10.0
F89-003	16.0	11.0		F05 F07	4x M6 x 10.0 4x M8 x 13.0	14	F05 F07	4x M6 x 10.0 4x M8 x 13.0
F89-004	16.0	11.0		F05 F07	4x M6 x 10.0 4x M8 x 13.0	14	F05 F07	4x M6 x 10.0 4x M8 x 13.0
F89-006	20.0	14.0		F05 F07	4x M6 x 10.0 4x M8 x 13.0	17	F05 F07	4x M6 x 10.0 4x M8 x 13.0
F89-009	20.0	14.0		F05 F07	4x M6 x 10.0 4x M8 x 13.0	17	F05 F07	4x M6 x 10.0 4x M8 x 13.0
F89-014	20.0	14.0		F07	4x M8 x 13.0	17	F07	4x M8 x 13.0
F89-020	25.0	18.0		F07 F10 F12	4x M8 x 13.0 4x M10 x 15.0 4x M12 x 19.0	22	F07 F10 F12	4x M8 x 13.0 4x M10 x 15.0 4x M12 x 19.0
F89-032	35.0		10 x 8	F10 F12	4x M10 x 15.0 4x M12 x 19.0	27	F10 F12	4x M10 x 15.0 4x M12 x 19.0
F89-052	35.0		10 x 8	F10 F12	4x M10 x 15.0 4x M12 x 19.0	27	F10 F12	4x M10 x 15.0 4x M12 x 19.0
F89-084*	50.0		14 x 9	F10 F14	4x M10 x 15.0 4x M16 x 24.0	36	F10 F14	4x M10 x 15.0 4x M16 x 24.0
F89-085	50.0		14 x 9	F12 F16	4x M12 x 19.0 4x M20 x 30.0	36	F12 F16	4x M12 x 19.0 4x M20 x 30.0
F89-139	45.0		14 x 9	F14	4x M16 x 24.0			
F89-140	50.0		14 x 9	F14	4x M16 x 24.0	46	F14	4x M16 x 24.0
F89-141	50.0		14 x 9	F12 F16	4x M12 x 19.0 4x M20 x 30.0	46	F12 F16	4x M12 x 19.0 4x M20 x 30.0
F89-240	70.0		20 x 12	F16 F25	4x M20 x 30.0 8x M16 x 24.0	46	F16 F25	4x M20 x 30.0 8x M16 x 24.0

NOTES

F89-084 is identical to F89-085 with F10-F14 flange

F89-140 is identical to F89-141 with F14 flange

* F89-084: F10 drilling not in body; please use optional F10 to F14 conversion plate

KEYSTONE F89 PNEUMATIC QUARTER-TURN ACTUATOR

GENERAL PURPOSE / HAZARDOUS AREA

TABLE 3B - VALVE CONNECTION KEYSTONE FLANGE

Model	F89U - Keystone metric (mm)					F89U - Keystone imperial (in)					Code*
	Bottom of shaft			PCD	Mounting holes No x Size x Depth	Bottom of shaft			PCD	Mounting holes No x Size x Depth	
	H	J	Key			H	J	Key			
F89-002	15.9	11.1		44.5	4x M6 x 10.0	5/8	7/16		1 3/4	4x 1/4-20 UNC x 0.38	AAA/AAC
F89-003	19.0	12.7		44.5 82.5	4x M6 x 10.0 4x M10 x 15.0	3/4	1/2		1 3/4 3 1/4	4x 1/4-20 UNC x 0.38 4x 3/8-16 UNC x 0.56	AAB BAD
F89-004	20.6		4.8 x 4.8	44.5 82.5	4x M6 x 10.0 4x M10 x 15.0	13/16		3/16 x 3/16	1 3/4 3 1/4	4x 1/4-20 UNC x 0.38 4x 3/8-16 UNC x 0.56	AAC BAC
F89-006	25.4		6.4 x 6.4	82.5	4x M10 x 15.0	1		1/4 x 1/4	3 1/4	4x 3/8-16 UNC x 0.56	BAD
F89-009	25.4		6.4 x 6.4	82.5	4x M10 x 15.0	1		1/4 x 1/4	3 1/4	4x 3/8-16 UNC x 0.56	BAD
F89-014	25.4		6.4 x 6.4	82.5	4x M10 x 15.0	1		1/4 x 1/4	3 1/4	4x 3/8-16 UNC x 0.56	BAD
F89-020	28.6		6.4 x 6.4	82.5 127.0	4x M10 x 15.0 4x M12 x 19.0	1 1/8		1/4 x 1/4	3 1/4 5	4x 3/8-16 UNC x 0.56 4x 1/2-13 UNC x 0.63	BAF CAF
F89-032	28.6		6.4 x 6.4	82.5 127.0	4x M10 x 15.0 4x M12 x 19.0	1 1/8		1/4 x 1/4	3 1/4 5	4x 3/8-16 UNC x 0.56 4x 1/2-13 UNC x 0.63	BAF CAF
F89-033	34.9		7.9 x 7.9	82.5 127.0	4x M10 x 15.0 4x M12 x 19.0	1 3/8		5/16 x 5/16	3 1/4 5	4x 3/8-16 UNC x 0.56 4x 1/2-13 UNC x 0.63	BAG CAG
F89-051	28.6		6.4 x 6.4	82.5 127.0	4x M10 x 15.0 4x M12 x 19.0	1 1/8		1/4 x 1/4	3 1/4 5	4x 3/8-16 UNC x 0.56 4x 1/2-13 UNC x 0.63	BAF CAF
F89-052	34.9		7.9 x 7.9	82.5 127.0	4x M10 x 15.0 4x M12 x 19.0	1 3/8		5/16 x 5/16	3 1/4 5	4x 3/8-16 UNC x 0.56 4x 1/2-13 UNC x 0.63	BAG CAG
F89-085	41.3		9.5 x 9.5	127.0 165.0	4x M12 x 19.0 4x M20 x 30.0	1 5/8		3/8 x 3/8	5 6 1/2	4x 1/2-13 UNC x 0.63 4x 3/4-10 UNC x 1.00	CAH DAH
F89-086	47.6		12.7 x 9.5	127.0 165.0	4x M12 x 19.0 4x M20 x 30.0	1 7/8		1/2 x 3/8	5 6 1/2	4x 1/2-13 UNC x 0.63 4x 3/4-10 UNC x 1.00	CAJ DAJ
F89-140	57.2		12.7 x 9.5	127.0 165.0	4x M12 x 19.0 4x M20 x 30.0	1 5/8		3/8 x 3/8	5 6 1/2	4x 1/2-13 UNC x 0.63 4x 3/4-10 UNC x 1.00	CAH DAH
F89-141	57.2		12.7 x 9.5	127.0 165.0	4x M12 x 19.0 4x M20 x 30.0	1 7/8		1/2 x 3/8	5 6 1/2	4x 1/2-13 UNC x 0.63 4x 3/4-10 UNC x 1.00	CAJ DAJ
F89-240	57.2		12.7 x 9.5	165.0	4x M20 x 30.0	2 1/4		1/2 x 3/8	6 1/2	4x 3/4-10 UNC x 1.00	DAK

NOTES

F89-033 is identical to F89-032 with larger bore

F89-051 is identical to F89-052 with smaller bore

F89-084 is identical to F89-085 with smaller bore

F89-141 is identical to F89-140 with larger bore

* Keystone mounting compatibility code

KEYSTONE F89 PNEUMATIC QUARTER-TURN ACTUATOR

GENERAL PURPOSE / HAZARDOUS AREA

TOP MOUNT DRILLING

The top mount drilling is available with metric or imperial threading. The dimensions of the hole pattern are identical.

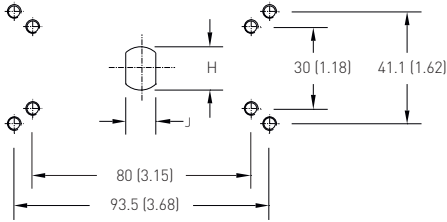

Top mounting drilling sizes 002 - 020

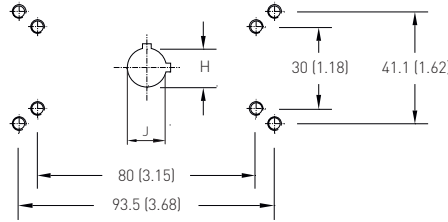

Top mounting drilling sizes 032 - 052

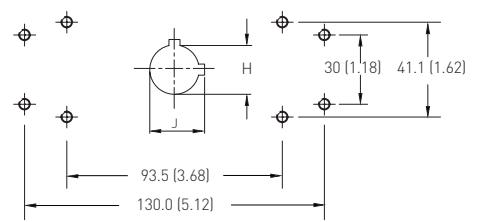

Top mounting drilling sizes 084 - 240

NOTES

- Metric threaded versions have a bolt threading of M5x1.0 x 10.0 mm deep.
- Imperial threaded versions have a bolt threading of 10-32 UNF x 0.28 inch deep.

NAMUR VDI/VDE 3845 MOUNTING

Full adoption to the VDI/VDE 3845 standard can be achieved with the introduction of a male insert into the female shaft.

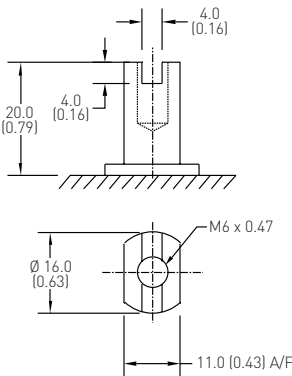

AIR CONNECTION

The actuator is controlled by applying compressed air to the 1/4" BSP/NPT ports (3/8" BSP/NPT for Model F89-240), or with a Namur solenoid valve.

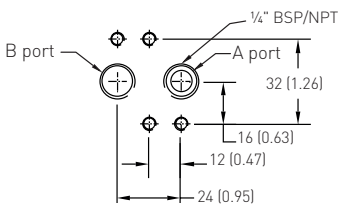

Air connection sizes 002 - 052

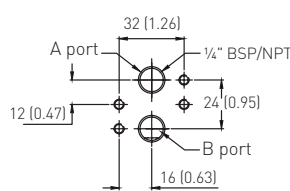

Air connection sizes 085 - 140

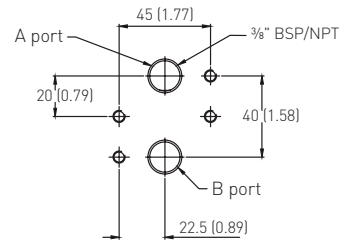

Air connection size 240

NOTES

- Metric threaded versions have a bolt threading of M5x1.0 x 10.0 mm deep.
- Imperial threaded versions have a bolt threading of 10-32 UNF x 0.28 inch deep.

KEYSTONE F89 PNEUMATIC QUARTER-TURN ACTUATOR

GENERAL PURPOSE / HAZARDOUS AREA

ACTUATOR PISTON DISPLACEMENT

Piston displacement is the total volume of pressurized air after the actuator has completed its stroke.

TABLE 4 - ACTUATOR VOLUME

Model	Opening		Closing	
	litres	cu.in	litres	cu.in
F89-002	0.11	6.7	0.09	5.5
F89-003	0.17	10.4	0.14	8.5
F89-004	0.25	15.3	0.21	12.8
F89-006	0.36	21.8	0.29	17.7
F89-009	0.57	34.9	0.48	29.3
F89-014	0.90	54.9	0.73	44.5
F89-020	1.37	83.8	1.08	65.9
F89-032/033	2.10	128.2	1.66	101.3
F89-051/052	3.10	189.2	2.63	160.5
F89-084/085/086	5.09	310.6	3.87	236.2
F89-139/140/141	8.92	544.3	6.81	415.6
F89-240	15.40	939.8	12.63	770.7

TABLE 5 - ACTUATOR CYCLING TIME (s)

Model	DA				SR			
	Travel time		Total time		Travel time		Total time	
	Opening	Closing	Opening	Closing	Opening	Closing	Opening	Closing
F89-002	0.1	0.0	0.1	0.0				
F89-003	0.1	0.1	0.1	0.1	0.8	0.8	1.5	1.5
F89-004	0.1	0.1	0.1	0.1	0.9	0.9	1.8	1.8
F89-006	0.1	0.1	0.1	0.1	1.1	1.1	2.1	2.1
F89-009	0.2	0.2	0.2	0.2	1.2	1.2	2.4	2.4
F89-014	0.3	0.2	0.3	0.3	1.4	1.4	2.7	2.7
F89-020	0.4	0.3	0.5	0.4	1.5	1.5	3.0	3.0
F89-032/033	0.5	0.5	0.7	0.6	2.3	2.3	4.5	4.5
F89-051/052	0.8	0.7	1.1	0.9	3.0	3.0	6.0	6.0
F89-084/085/086	1.2	0.8	1.8	1.0				
F89-139/140/141	2.3	2.2	3.2	2.3				
F89-240	3.2	3.1	5.5	4.3				

NOTES

1. The actuator cycling time consist of a time required to build up the pressure and secondly move the pistons and valve (travel time). The sum of these values is the total cycling time.
2. The actuator cycle time varies with the supplied air pressure, solenoid valve, and required valve torque, and are for indication only.
3. Indicated times above are based on bare actuator using 5.5 bar (80 psi) air pressure and a solenoid valve with C_v of 1300 l/m (46 CFM).

TABLE 6 - ACTUATOR WEIGHT

Model	DA		SR	
	kg	lbs	kg	lbs
F89-002	1.0	2.2	-	-
F89-003	1.4	3.1	1.7	3.7
F89-004	2.1	4.6	2.6	5.7
F89-006	2.9	6.4	3.6	7.9
F89-009	3.7	8.2	4.9	10.8
F89-014	5.3	11.7	7.3	16.1
F89-020	7.9	17.4	11.0	24.3
F89-032/033	12.1	26.7	16.7	36.8
F89-051/052	18.3	40.3	24.9	54.9
F89-084/085/086	27.8	61.3	39.7	87.5
F89-139/140/141	45.8	101.0	69.5	153.2
F89-240	77.5	170.9	112.4	247.8

KEYSTONE F89 PNEUMATIC QUARTER-TURN ACTUATOR

GENERAL PURPOSE / HAZARDOUS AREA

MATERIALS OF CONSTRUCTION

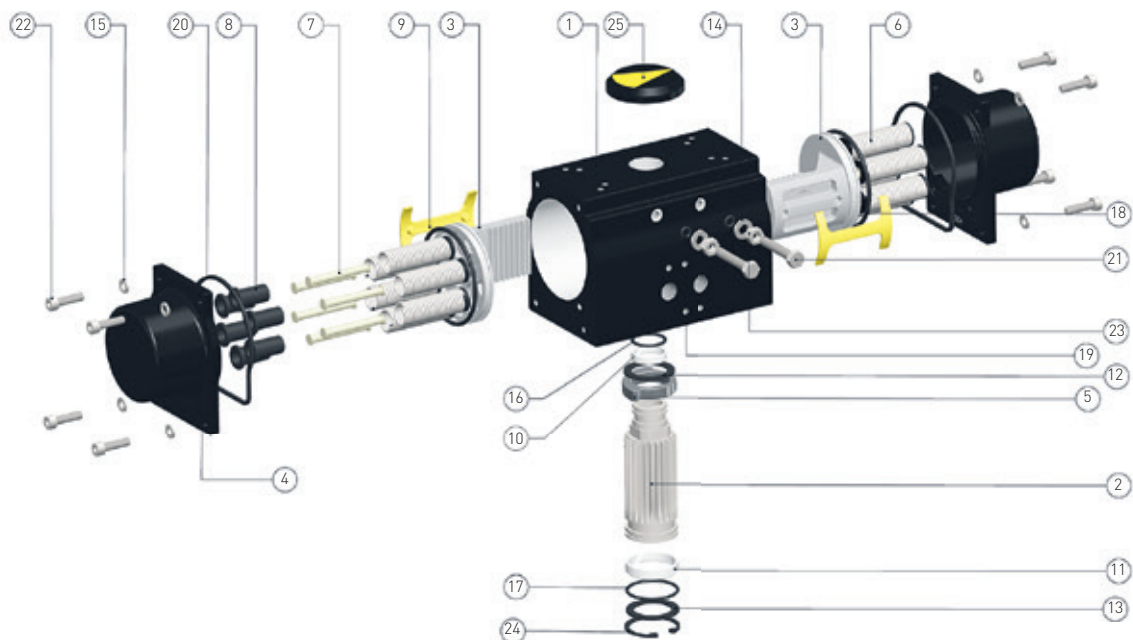

TABLE 7 - MATERIALS OF CONSTRUCTION

No.	Item	Material	US material std	BS material std	DIN material std	Finish
1	Body	Extruded aluminium ASTM B221 type 6063T6	ASTM B221	BS 1474 6063	DIN 3.33206.51	Anodized 5-8 microns + ESPC 60-80 microns
2	Pinion	Hot rolled carbon steel bar ASTM A108 grade 1045	A108	BS 970 080M40	C40	Zink-Nickel plated 8-12 microns
3	Piston	Die cast aluminium alloy ASTM B85 type A380 /BS 1490 grade LM24	ASTM B85	BS 1490	DIN 1725-2300 or 226	Anodized
4	End cap	Die cast aluminium alloy ASTM B85 type A380/BS 1490 grade LM24	ASTM B85	BS 1490	DIN 1725-2300 or 226	ESPC 60-80 microns
5	Cam	Cast grade SAE 1045/C45 / EN8				Blackodised
6	Spring	Spring steel as per ASTM A401	ASTM A401	BS 5216 HS3	DIN 17223 PtI	Epoxy coated 30-40 microns
7	Spring retainer	Carbon steel				Zinc plated
8	Spring cup	Die cast aluminium alloy ASTM B85 type A380 /BS 1490 grade LM24	ASTM B85	BS 1490	DIN1725-2300 or 226	Anodized
9	Piston guide	Zytel 101F NC010				Natural
10	Top bearing	PAR ⁽¹⁾ + 25% glass filled				Natural
11	Bottom bearing	PAR ⁽¹⁾ + 25% glass filled				Natural
12	Top thrust washer	PA66 ⁽²⁾				Natural
13	Bottom thrust washer	PA66 ⁽²⁾				Natural
14	Travel stop washer	SS ⁽³⁾ ISO 3506 A2-70 grade				Natural
15	End cap washer (spring washer)	SS ⁽³⁾ ISO 3506 A2-70 grade				Natural
16	Top O-ring (pinion)	NBR shore 70 A				Natural
17	Bottom O-ring (pinion)	NBR shore 70 A				Natural
18	O-ring (piston)	NBR shore 70 A				Natural
19	O-ring (travel stop)	NBR shore 70 A				Natural
20	Gasket (end cap)	NBR shore 70 A				Natural
21	Bolt - travel stop	SS ⁽³⁾ ISO 3506 A2-70 grade				Natural
22	Bolt - end cap	SS ⁽³⁾ ISO 3506 A2-70 grade				Natural
23	Nut - travel stop	SS ⁽³⁾ ISO 3506 A2-70 grade				Natural
24	Circlip (bottom)	Carbon steel				Zink-Nickel plated
25	Position indicator	ABS plastic				Natural

1. POM Acetal Resin

2. Polyamide grade 66

3. Stainless steel

KEYSTONE F89 PNEUMATIC QUARTER-TURN ACTUATOR

GENERAL PURPOSE / HAZARDOUS AREA

TORQUE OUTPUT

Double acting actuator

For sizing of double acting actuators use the following table and select the actuator which will provide nearest torque output above the anticipated torque of the valve and required safety factor.

TABLE 8 - DA TORQUE (Nm)

Model	Air pressure (bar)						
	3	4	5	5.5	6	7	8.3
F89-002	11	15	19	21	23	26	31
F89-003	17	22	28	31	33	39	46
F89-004	25	34	42	46	50	59	70
F89-006	36	48	60	66	72	84	100
F89-009	58	77	96	106	116	135	160
F89-014	90	121	151	166	181	211	250
F89-020	132	177	221	243	265	309	366
F89-032/033	208	277	346	381	416	485	575
F89-051/052	315	420	525	577	630	735	871
F89-084/085	525	700	875	963	1051	1226	1453
F89-140/141	875	1167	1458	1604	1750	2041	2421
F89-240	1508	2011	2514	2765	3016	3519	4173

TABLE 9 - DA TORQUE (in-lb)

Model	Air pressure (psi)						
	40	60	70	80	90	100	120
F89-002	100	134	167	184	201	234	277
F89-003	147	197	246	270	295	344	408
F89-004	223	297	372	409	446	521	617
F89-006	320	427	534	587	641	747	886
F89-009	512	683	853	938	1024	1194	1416
F89-014	801	1068	1334	1468	1601	1868	2215
F89-020	1173	1563	1954	2150	2345	2736	3244
F89-032/033	1841	2455	3068	3375	3682	4295	5093
F89-051/052	2789	3718	4648	5112	5577	6507	7715
F89-084/085	4652	6203	7754	8529	9304	10855	12871
F89-140/141	7749	10332	12915	14206	15497	18080	21438
F89-240	13357	17810	22262	24489	26715	31167	36955

Spring return actuator

Sizing of spring return actuators is more complex. First you need to determine the desired 'failure mode' (fail open or fail closed). Secondly you need to determine the critical torque points for the subject valve using the table below.

Butterfly valves 'fail closed'	Butterfly valves 'fail open'
Start of air torque	Start of spring torque
End of spring torque	End of air torque

Ball valves 'fail closed'	Ball valves 'fail open'
Start of air (unseating) torque	Start of spring (unseating) torque
End of air (full open) torque	End of spring (full open) torque
Start of spring (breakout from open) torque	Start of air (breakout from open) torque
End of spring (re-seating) torque	End of air (re-seating) torque

KEYSTONE F89 PNEUMATIC QUARTER-TURN ACTUATOR

GENERAL PURPOSE / HAZARDOUS AREA

TABLE 10 - SR TORQUE (Nm)

Model	Number of springs	Air pressure (bar)														Spring torque		
		3		4		5		5.5		6		7		8.3		SST	SET	
		AST	AET	AST	AET	AST	AET	AST	AET	AST	AET	AST	AET	AST	AET			
F89-003	4	11	8	16	13	22	19	25	22	28	24	33	30	40	37	9	6	
	5	9	6	15	11	21	17	23	19	26	22	32	28	39	35	11	7	
	6	8	3	14	9	19	14	22	17	25	20	30	26	37	33	13	9	
	7	7	1	12	7	18	12	20	15	23	18	29	23	36	31	16	10	
	8			11	4	16	10	19	13	22	16	27	21	34	28	18	12	
	9			9	2	15	8	17	11	20	13	26	19	33	26	20	13	
	10					13	6	16	8	19	11	24	17	32	24	22	15	
	11					12	3	15	6	17	9	23	14	30	22	24	16	
	12							13	4	16	7	21	12	29	19	27	17	
	F89-004	4	17	12	25	21	33	29	38	33	42	37	50	46	61	57	13	9
		5	15	9	23	17	31	26	36	30	40	34	48	43	59	53	16	11
		6	12	6	21	14	29	23	33	27	38	31	46	39	57	50	19	13
7		10	3	19	11	27	19	31	23	35	28	44	36	55	47	23	15	
8				17	8	25	16	29	20	33	24	42	33	53	44	26	17	
9				14	4	23	13	27	17	31	21	40	30	50	41	29	19	
10						21	10	25	14	29	18	37	26	48	37	32	21	
11						19	6	23	11	27	15	35	23	46	34	36	23	
12								21	7	25	11	33	20	44	31	39	26	
F89-006		4	24	13	36	25	48	37	54	43	60	49	72	61	88	77	23	12
		5	21	7	33	19	45	31	51	37	57	43	69	55	85	71	29	15
		6	18	2	30	14	42	26	48	32	54	38	66	50	82	65	34	18
	7			27	8	39	20	45	26	51	32	63	44	79	60	40	21	
	8			24	2	36	14	42	20	48	26	60	38	76	54	46	24	
	9					33	9	39	15	45	21	57	33	73	48	51	27	
	10					30	3	36	9	42	15	54	27	70	43	57	30	
	11							33	3	39	9	51	21	67	37	63	33	
	12									37	4	49	16	64	31	69	36	
	F89-009	4	38	29	58	48	77	67	87	77	96	86	115	106	140	131	29	19
		5	33	21	53	41	72	60	82	70	91	79	111	98	136	123	36	24
		6	29	14	48	33	67	53	77	62	86	72	106	91	131	116	44	29
7		24	7	43	26	62	45	72	55	82	65	101	84	126	109	51	34	
8				38	19	57	38	67	48	77	57	96	77	121	102	58	39	
9				33	11	53	31	62	40	72	50	91	69	116	94	66	44	
10						48	23	57	33	67	43	86	62	111	87	73	49	
11						43	16	52	26	62	35	81	55	106	80	80	53	
12								48	18	57	28	77	47	102	72	88	58	
F89-014		4	60	46	91	76	121	106	136	121	151	136	181	166	220	205	45	30
		5	53	35	83	65	113	95	128	110	143	125	173	155	213	194	56	38
		6	45	23	75	53	106	84	121	99	136	114	166	144	205	183	67	45
	7	38	12	68	42	98	72	113	88	128	103	158	133	198	172	78	53	
	8			60	31	91	61	106	76	121	91	151	122	190	161	89	60	
	9			53	20	83	50	98	65	113	80	143	110	183	150	101	68	
	10					76	39	91	54	106	69	136	99	175	138	112	75	
	11					68	28	83	43	98	58	128	88	168	127	123	83	
	12							76	32	91	47	121	77	160	116	134	90	
	F89-020	4	86	62	130	107	174	151	196	173	218	195	262	239	320	296	70	47
		5	74	45	118	89	162	133	184	155	206	177	251	221	308	279	88	58
		6	62	27	107	72	151	116	173	138	195	160	239	204	296	261	105	70
7		51	10	95	54	139	98	161	120	183	142	227	186	285	244	123	82	
8				83	37	127	81	149	103	171	125	216	169	273	226	140	93	
9				72	19	116	63	138	85	160	107	204	151	261	209	158	105	
10						104	46	126	68	148	90	192	134	250	191	175	117	
11						92	28	114	50	136	72	181	116	238	174	193	128	
12								103	33	125	55	169	99	226	156	210	140	

KEYSTONE F89 PNEUMATIC QUARTER-TURN ACTUATOR

GENERAL PURPOSE / HAZARDOUS AREA

TABLE 10 - SR TORQUE (Nm) continued

Model	Number of springs	Air pressure (bar)														Spring torque		
		3		4		5		5.5		6		7		8.3		SST	SET	
		AST	AET	AST	AET	AST	AET	AST	AET	AST	AET	AST	AET	AST	AET			
F89-032/033	4	134	96	203	166	272	235	307	270	341	304	411	374	501	464	111	74	
	5	115	69	184	138	254	207	288	242	323	276	392	346	482	436	139	93	
	6	96	41	166	110	235	179	270	214	304	249	374	318	464	408	167	111	
	7	78	13	147	82	216	151	251	186	286	221	355	290	445	380	195	130	
	8			129	54	198	124	232	158	267	193	336	262	426	352	223	149	
	9			110	26	179	96	214	130	249	165	318	234	408	324	251	167	
	10					161	68	195	102	230	137	299	206	389	296	279	186	
	11					142	40	177	75	211	109	281	178	371	269	307	204	
	12							158	47	193	81	262	151	352	241	334	223	
	F89-051/052	4	195	135	300	240	405	345	457	398	510	450	615	555	751	691	180	120
		5	165	90	270	195	375	300	428	353	480	405	585	510	721	647	225	150
		6	135	45	240	150	345	255	398	308	450	360	555	465	691	602	269	180
7		105	1	210	105	315	210	368	263	420	315	525	420	662	557	314	210	
8				180	61	285	166	338	218	390	270	495	375	632	512	359	240	
9				150	16	255	121	308	173	360	226	465	331	602	467	404	269	
10						225	76	278	128	330	181	435	286	572	422	449	299	
11						195	31	248	83	300	136	405	241	542	377	494	329	
12								218	38	270	91	375	196	512	332	539	359	
F89-084/085		4	329	231	504	406	679	581	767	669	855	757	1030	932	1257	1159	294	196
		5	280	157	455	332	630	507	718	595	806	683	981	858	1208	1085	368	245
		6	231	83	406	258	581	433	669	521	757	609	932	784	1159	1011	442	294
	7	181	10	356	185	531	360	619	448	707	536	882	711	1109	938	515	344	
	8			307	111	482	286	570	374	658	462	833	637	1060	864	589	393	
	9			258	37	433	212	521	300	609	388	784	563	1011	790	663	442	
	10					384	139	472	227	560	315	735	490	962	717	736	491	
	11					335	65	423	153	511	241	686	416	913	643	810	540	
	12							374	80	462	168	637	343	864	570	883	589	
	F89-139/140/141	4	548	384	840	676	1131	967	1277	1113	1423	1259	1714	1550	2094	1930	491	327
		5	466	262	758	554	1049	845	1195	991	1341	1137	1632	1428	2012	1808	613	409
		6	384	139	676	431	967	722	1113	868	1259	1014	1550	1305	1930	1685	736	491
7		303	16	595	308	886	599	1032	745	1178	891	1469	1182	1849	1562	859	572	
8				513	186	804	477	950	623	1096	769	1387	1060	1767	1440	981	654	
9				431	63	722	354	868	500	1014	646	1305	937	1685	1317	1104	736	
10						640	231	786	377	932	523	1223	814	1603	1194	1227	818	
11						558	109	704	255	850	401	1141	692	1521	1072	1349	900	
12								623	132	769	278	1060	569	1440	949	1472	981	
F89-240		4	954	676	1457	1179	1960	1682	2211	1933	2462	2184	2965	2687	3619	3341	832	554
		5	815	469	1318	972	1821	1475	2072	1726	2323	1977	2826	2480	3480	3134	1039	693
		6	676	261	1179	764	1682	1267	1933	1518	2184	1769	2687	2272	3341	2926	1247	832
	7	538	53	1041	556	1544	1059	1795	1310	2046	1561	2549	2064	3203	2718	1455	970	
	8			902	348	1405	851	1656	1102	1907	1353	2410	1856	3064	2510	1663	1109	
	9			764	140	1267	643	1518	894	1769	1145	2272	1648	2926	2302	1871	1247	
	10					1128	435	1379	686	1630	937	2133	1440	2787	2094	2079	1386	
	11					990	227	1241	478	1492	729	1995	1232	2649	1886	2287	1524	
	12							1102	270	1353	521	1856	1024	2510	1678	2495	1663	

KEYSTONE F89 PNEUMATIC QUARTER-TURN ACTUATOR

GENERAL PURPOSE / HAZARDOUS AREA

TABLE 11 - SR TORQUE (in-lb)

Model	Number of springs	Air pressure (psi)														Spring torque	
		40		60		70		80		90		100		120		SST	SET
		AST	AET	AST	AET	AST	AET	AST	AET	AST	AET	AST	AET	AST	AET		
F89-003	4	97	71	142	115	195	168	221	195	248	213	292	266	354	328	80	53
	5	80	53	133	97	186	151	204	168	230	195	283	248	345	310	97	62
	6	70	30	120	79	169	128	193	153	218	177	267	226	331	290	118	77
	7	58	10	107	59	156	108	180	133	205	157	254	207	318	270	137	90
	8			94	39	143	89	168	113	192	138	241	187	305	251	157	103
	9			81	20	130	69	155	94	179	118	229	167	292	231	177	116
	10					117	49	142	74	167	99	216	148	280	212	196	128
	11					105	30	129	54	154	79	203	128	267	192	216	141
	12							116	35	141	59	190	108	254	172	236	154
F89-004	4	151	106	221	186	292	257	337	292	372	328	443	407	540	505	115	80
	5	133	80	204	151	275	230	319	266	354	301	425	381	523	469	142	97
	6	110	51	184	125	259	200	296	237	333	274	407	348	504	445	172	113
	7	91	22	165	97	240	171	277	208	314	245	388	320	485	416	201	132
	8			146	68	221	142	258	179	295	217	369	291	466	388	230	151
	9			127	39	202	113	239	151	276	188	351	262	447	359	258	170
	10					183	85	220	122	257	159	332	233	428	330	287	189
	11					164	56	201	93	238	130	313	205	409	301	316	208
	12							182	65	220	102	294	176	391	273	344	227
F89-006	4	214	117	320	223	426	329	479	382	533	435	639	541	777	679	202	105
	5	188	66	294	172	400	278	453	332	506	385	613	491	751	629	253	131
	6	162	15	268	122	374	228	427	281	480	334	586	440	724	578	303	157
	7			242	71	348	177	401	230	454	284	560	390	698	528	354	183
	8			215	21	322	127	375	180	428	233	534	339	672	477	404	210
	9					295	76	348	129	402	183	508	289	646	427	455	236
	10					269	26	322	79	375	132	482	238	620	376	505	262
	11							296	28	349	82	455	188	594	326	556	288
	12									323	31	429	137	567	275	606	314
F89-009	4	337	257	514	425	682	593	771	682	850	762	1019	939	1240	1160	257	168
	5	292	186	469	363	638	531	726	620	806	700	983	868	1204	1089	319	213
	6	254	124	424	295	595	466	680	551	765	636	936	807	1158	1029	388	258
	7	210	60	381	230	552	401	637	486	722	572	893	742	1115	964	452	301
	8			338	166	509	336	594	422	679	507	850	678	1072	900	517	344
	9			295	101	466	272	551	357	636	443	807	613	1029	835	581	388
	10					423	207	508	293	593	378	764	549	986	770	646	431
	11					380	143	465	228	550	313	721	484	943	706	710	474
	12							422	163	507	249	678	419	900	641	775	517
F89-014	4	531	407	806	673	1072	939	1204	1072	1337	1204	1603	1470	1948	1816	399	266
	5	469	310	735	576	1001	841	1134	974	1266	1107	1532	1373	1886	1718	496	337
	6	402	207	669	474	936	741	1069	874	1202	1008	1469	1274	1816	1621	594	399
	7	335	108	602	375	869	642	1002	775	1136	909	1403	1175	1750	1522	693	465
	8			536	276	803	543	936	676	1069	810	1336	1076	1683	1423	792	532
	9			469	177	736	444	870	577	1003	711	1270	978	1617	1324	891	598
	10					670	345	803	478	937	612	1203	879	1550	1226	990	665
	11					603	246	737	379	870	513	1137	780	1484	1127	1089	731
	12							670	280	804	414	1070	681	1417	1028	1188	798
F89-020	4	762	549	1151	948	1541	1337	1736	1532	1931	1727	2320	2117	2834	2622	620	416
	5	655	399	1045	788	1435	1178	1630	1373	1824	1568	2223	1957	2728	2471	779	514
	6	553	243	943	633	1334	1024	1530	1220	1725	1415	2116	1806	2624	2314	930	620
	7	449	88	840	478	1231	869	1426	1065	1622	1260	2013	1651	2521	2159	1085	723
	8			737	323	1128	714	1323	910	1518	1105	1909	1496	2418	2004	1240	827
	9			633	168	1024	559	1220	755	1415	950	1806	1341	2314	1849	1395	930
	10					921	404	1116	600	1312	795	1703	1186	2211	1694	1550	1033
	11					818	249	1013	445	1208	640	1599	1031	2107	1539	1705	1137
	12							910	290	1105	485	1496	876	2004	1384	1860	1240

KEYSTONE F89 PNEUMATIC QUARTER-TURN ACTUATOR

GENERAL PURPOSE / HAZARDOUS AREA

TABLE 11 - SR TORQUE (in-lb) continued

Model	Number of springs	Air pressure (psi)												Spring torque			
		40		60		70		80		90		100		120		SST	SET
		AST	AET	AST	AET	AST	AET	AST	AET	AST	AET	AST	AET	AST	AET		
F89-032/033	4	1187	850	1798	1470	2409	2081	2719	2391	3020	2692	3640	3312	4437	4109	983	655
	5	1019	611	1630	1222	2250	1833	2551	2143	2861	2444	3472	3064	4269	3861	1231	824
	6	854	360	1467	974	2081	1587	2388	1894	2695	2201	3308	2815	4106	3612	1481	987
	7	689	113	1303	727	1916	1341	2223	1647	2530	1954	3144	2568	3942	3366	1728	1152
	8			1138	480	1752	1094	2059	1401	2366	1707	2979	2321	3777	3119	1974	1316
	9			974	233	1587	847	1894	1154	2201	1461	2815	2074	3612	2872	2221	1481
	10					1423	600	1730	907	2037	1214	2650	1828	3448	2625	2468	1645
	11					1258	353	1565	660	1872	967	2486	1581	3283	2378	2715	1810
	12							1401	413	1707	720	2321	1334	3119	2132	2962	1974
F89-051/052	4	1727	1196	2657	2126	3587	3056	4047	3525	4517	3985	5447	4915	6651	6120	1594	1063
	5	1461	797	2391	1727	3321	2657	3791	3126	4251	3587	5181	4517	6386	5730	1993	1328
	6	1198	402	2127	1332	3057	2261	3522	2726	3986	3191	4916	4120	6124	5329	2386	1591
	7	933	5	1862	934	2792	1864	3256	2328	3721	2793	4651	3723	5859	4931	2784	1856
	8			1597	536	2526	1466	2991	1931	3456	2395	4386	3325	5594	4533	3182	2121
	9			1332	139	2261	1068	2726	1533	3191	1998	4120	2927	5329	4136	3580	2386
	10					1996	670	2461	1135	2926	1600	3855	2530	5064	3738	3977	2652
	11				1731	273	2196	737	2661	1202	3590	2132	4799	3340	4375	2917	
	12							1931	340	2395	805	3325	1734	4533	2942	4773	3182
F89-084/085	4	2916	2048	4467	3599	6018	5150	6793	5925	7568	6700	9119	8251	11135	10267	2604	1736
	5	2482	1393	4033	2944	5584	4494	6359	5270	7134	6045	8685	7596	10701	9612	3259	2170
	6	2048	738	3599	2288	5150	3839	5925	4614	6700	5390	8251	6940	10267	8956	3915	2604
	7			3156	1642	4707	3192	5482	3968	6258	4743	7808	6294	9824	8310	4561	3047
	8			2722	986	4273	2537	5048	3312	5824	4088	7374	5638	9390	7654	5217	3481
	9					3839	1882	4614	2657	5390	3432	6940	4983	8956	6999	5872	3915
	10					3405	1235	4180	2010	4956	2786	6506	4337	8522	6352	6518	4349
	11				2971	580	3746	1355	4522	2130	6072	3681	8088	5697	7174	4783	
	12							3312	709	4088	1484	5638	3035	7654	5051	7820	5217
F89-139/140/141	4	4853	3400	7436	5983	10018	8566	11310	9857	12601	11149	15184	13732	18542	17090	4349	2896
	5	4126	2320	6709	4903	9292	7485	10584	8777	11875	10068	14458	12651	17816	16009	5429	3622
	6	3400	1230	5983	3813	8566	6396	9857	7688	11149	8979	13732	11562	17090	14920	6518	4349
	7			5266	2724	7849	5307	9140	6598	10431	7890	13014	10473	16372	13830	7608	5066
	8			4539	1643	7122	4226	8414	5518	9705	6809	12288	9392	15646	12750	8688	5792
	9					6396	3137	7688	4428	8979	5720	11562	8303	14920	11660	9778	6518
	10					5670	2047	6961	3339	8253	4630	10836	7213	14193	10571	10867	7245
	11				4944	967	6235	2258	7527	3550	10109	6133	13467	9491	11948	7971	
	12						5518	1169	6809	2461	9392	5043	12750	8401	13037	8688	
F89-240	4	8451	5989	12903	10441	17356	14894	19582	17120	21808	19346	26261	23798	32049	29587	7369	4907
	5	7220	4155	11672	8608	16125	13060	18351	15286	20577	17513	25030	21965	30818	27753	9202	6138
	6	5989	2313	10441	6766	14894	11218	17120	13444	19346	15671	23798	20123	29587	25911	11044	7369
	7			9219	4923	13671	9376	15898	11602	18124	13828	22576	18281	28364	24069	12886	8591
	8			7988	3081	12440	7534	14667	9760	16893	11986	21345	16439	27133	22227	14729	9822
	9					11218	5692	13444	7918	15671	10144	20123	14596	25911	20385	16571	11044
	10					9987	3849	12213	6076	14439	8302	18892	12754	24680	18543	18413	12275
	11				8765	2007	10991	4233	13217	6460	17670	10912	23458	16700	20255	13497	
	12						9760	2391	11986	4618	16439	9070	22227	14858	22097	14729	

KEYSTONE F89 PNEUMATIC QUARTER-TURN ACTUATOR

ORDERING GUIDE

Example:	89E	020	03	08	N14	N	2	M	00	M10	D25
Figure number											
89D	ISO 5211 flange and shaft										
89E	ISO flange and Keystone shaft										
89U	Keystone flange and shaft										
Model/Size											
002	002	020	020	085	085						
003	003	032	032	140	140						
004	004	033	033	141	141						
006	006	051	051	240	240						
009	009	052	052								
014	014	084	084								
Action											
01	DA										
03	SR FC CW (std)										
04	SR FC CCW										
Spring rating											
04	4 springs	08	8 springs	12	12 springs						
05	5 springs	09	9 springs	XX	not applicable						
06	6 springs	10	10 springs								
07	7 springs	11	11 springs								
Air connection											
N14	¼" NPT	P14	¼" BSPP								
N38	⅜" NPT	P38	⅜" BSPP								
Temperature range											
H	High temp (FKM)										
N	Standard (NBR)										
L	Low temp										
Travel stops											
2	Dual shaft (std)										
3	End cap (single)										
4	End cap (double)										
Flange threading											
M	Metric										
U	Imperial										
Variant											
00	Standard										
A4	A4 SS bolts										
Valve flange*											
F03	PCD 36 mm (ISO 5211)	M05	F03 + F05 (ISO 5211)	U1C	PCD 1.75" (Keystone 45 degrees)						
F04	PCD 42 mm (ISO 5211)	M07	F05 + F07 (ISO 5211)	U34	PCD 3.25" (Keystone 45 degrees)						
F05	PCD 50 mm (ISO 5211)	M10	F07 + F10 + F12 (ISO 5211)	U50	PCD 5.00" (Keystone 45 degrees)						
F07	PCD 70 mm (ISO 5211)	M12	F10 + F12 (ISO 5211)	U68	PCD 6.50" (Keystone 45 degrees)						
F10	PCD 102 mm (ISO 5211)	M14	F10 + F14 (ISO 5211)								
F12	PCD 125 mm (ISO 5211)	M16	F12 + F16 (ISO 5211)	C34	PCD 1.75 + 3.25" (Keystone 45 degrees)						
F14	PCD 140 mm (ISO 5211)			C50	PCD 3.25 + 5.00" (Keystone 45 degrees)						
F16	PCD 165 mm (ISO 5211)			C68	PCD 5.00 + 6.50" (Keystone 45 degrees)						
Shaft*											
S11	Star 11	D12	E1 - DD12 x 8	P06	DD ⅜" x ¼" [9.53 x 6.35 mm]						
S14	Star 14	D16	E2 - DD16 x 11	P09	DD ⅞" x ⅜" [14.29 x 9.53 mm]						
S17	Star 17	D20	E3 - DD20 x 14	P0A	DD ⅞" x 7/16" [15.88 x 11.1 mm]						
S22	Star 22	D25	E4 - DD25 x 18	P0C	DD ¾" x ½" [19.05 x 12.7 mm]						
S27	Star 27	D30	E5 - DD30 x 22	P0E	DD ⅞" x ⅝" [22.2 x 15.88 mm]						
S36	Star 36	M35	E6 - 35K10	U0D	Dia 1⅜"; K 3/16 x 3/16" [20.6K4.78 mm]						
S46	Star 46	M40	E7 - 40K12	U10	Dia 1"; K 1½x¼" [25.4K6.35 mm]						
S55	Star 55	M44	E8 - 44K12	U12	Dia 1⅞"; K ¼x¼" [28.8K6.35 mm]						
S75	Star 75	M50	E9 - 50K14	U16	Dia 1⅞"; K 5/16 x 5/16" [34.9K7.94 mm]						
		M60	E0 - 60K18	U1A	Dia 1⅞"; K 3/8 x 3/8" [41.3K9.53 mm]						
		M70	EA - 70K20	U1E	Dia 1⅞"; K ½ x 3/8" [47.6K12.7 mm]						
		M80	EB - 80K22	U24	Dia 2¼"; K ½ x 3/8" [57.2K12.7 mm]						
		M90	EC - 90K25	U26	Dia 2⅞"; K 5/8" [63.3K15.9 mm]						
		MA0	ED - 100K28	U2C	Dia 2¾"; K 5/8" [69.9K15.9 mm]						
		MS0	Bore 30 x K8 (Keystone)	U38	Dia 3½"; K 7/8" [88.9K22.23 mm]						

* Please consult technical pages for the specific flange and shaft details per model.

Neither Emerson, Emerson Automation Solutions, nor any of their affiliated entities assumes responsibility for the selection, use or maintenance of any product. Responsibility for proper selection, use, and maintenance of any product remains solely with the purchaser and end user.

Keystone is a mark owned by one of the companies in the Emerson Automation Solutions business unit of Emerson Electric Co. Emerson Automation Solutions, Emerson and the Emerson logo are trademarks and service marks of Emerson Electric Co. All other marks are the property of their respective owners.

The contents of this publication are presented for informational purposes only, and while every effort has been made to ensure their accuracy, they are not to be construed as warranties or guarantees, express or implied, regarding the products or services described herein or their use or applicability. All sales are governed by our terms and conditions, which are available upon request. We reserve the right to modify or improve the designs or specifications of such products at any time without notice.

Emerson.com/FinalControl